



# messenger

MIDWEST INSULATION CONTRACTORS ASSOCIATION

7250 POE AVE., SUITE 410 - DAYTON, OH 45414 - micainsulation.org



**VOLUME 57 NO. 5  
MAY 2023**



## WHAT'S INSIDE THIS MONTH:

- Safety and Employment Law Tidbits
- President's Message
- MICA Leadership/Board of Directors
- 2023 MICA Convention Registration Form
- Schedule of Events June 2023 Convention
- Total Construction Jumps in March to Three Month High, Bolstered by Nonbuilding Strength
- Save the Date
- US Department of Labor announces launch of 'Beat the Heat' contest
- Connect With Regional Veterans' Employment Coordinators



### **Safety and Employment Law Tidbits**

*With Gary Auman, MICA Legal Counsel*

#### **No confidentiality clauses in severance agreements**

Often, when an employer terminates an employee, the employer and employee enter into a severance agreement whereby the employer agrees to pay that employer money in exchange for the employee's promise to release the employer from employment-related liability.

These severance agreements almost always include confidentiality clauses. Confidentiality clauses are important for many reasons, not the least of which is that the employer may not want that former employer to tell other employees about the money just paid to them.

However, the National Labor Relations board recently issued a decision prohibiting confidentiality clause in severance agreements. On February 21, 2023, in McLaren Macomb, the NLRB ruled that broad confidentiality clauses interfere with the employees' right to organize and bargain collectively ["Section 7 rights."] The Board held that an employer commits an unfair labor

practice by including a confidentiality clause in a severance agreement, regardless of whether the employer seeks to enforce its rights under the contract.

Employers seeking to enter a severance agreement with an employee should check with an attorney to determine whether a confidentiality clause is necessary and whether it could be drafted in such manner that would not restrict Section 7 rights.

#### **NLRB Increases Damage Awards to Aggrieved Employees**

On December 13, 2022, the NLRB increased the penalties for unfair labor practices. Until then, the penalty for committing an unfair labor act was reinstatement, back pay going back to the violation, and the cost of any lost benefits. But now, the penalty includes "all direct or foreseeable" harms. These would be damages arising because the employee had been terminated from employment. For example, such damages could include costs from interest and penalties on unpaid credit card bills, withdrawal penalties for 401(k) loans, or even the costs of home mortgage foreclosure might be consequential damages.

#### **Non-Compete Agreements**

The Federal Trade Commission has proposed a rule banning non-compete agreements in employment contracts. The FTC had opened a comment period until March 20. But, due to the overwhelming number of responses, the FTC has extended the comment period from March 20 to April 19.

#### **Instance by Instance**

Starting on March 27th, OSHA began following "instance by instance" citation procedure. This means that OSHA can assess a separate penalty for each employee exposed to a cited hazard. For example, assume an employer did not provide fall protection for three employees working on a roof. Under the old citation procedure, OSHA would have issued one penalty for failure to provide fall protection. However, under the "instance by instance" method, OSHA can now assess a separate penalty for each of the three employees exposed to the hazard. This will apply to the following areas: fall protection, trenching, machine guarding, respiratory protection, permit required confined space, lockout tagout, and some recordkeeping provisions.

A Product of MC&I



TANK INSULATION PANELS

**MCI-RIDGLOK.com**



### Contractor Advantages

- Labor Savings
- Small Crew Size
- Minimal to NO Welding
- Minimal Specialty Tools
- No Scaffolding
- Pre-Fabricated Panel

### End User Advantages

- High Wind Designs
- Longest Lifespan
- Easy Repairs
- Minimum Maintenance
- Freeze Protection
- Strong Weather Barrier



**ALL INDUSTRIES—ALL TANKS**

Heated/Cold • Large/Small | Welded • Bolted • Concrete • Plastic

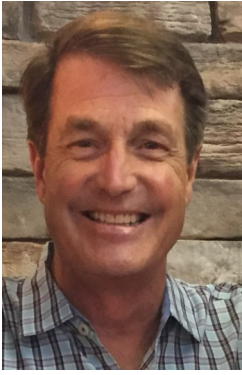

## PRESIDENT'S MESSAGE

### FREE MARRIAGE TIP:

Don't ask your wife when dinner will be ready while she's mowing the lawn.

Happy Spring MICA Members, I know that the weather up north has not exactly been like spring weather. I spoke to Lance Pickerign from Gagnon Insulation two weeks ago and he informed me that the Twin Cities had another snowstorm with about three feet of accumulated snow. Mother nature always has her way and there is not much we can do about.

I just had an article sent to me regarding the FMIA Act that was reintroduced on December 2, 2022, by Representative Linda Sanchez. The Federal Mechanical Insulation Act is supported by many of the small business contractors who are members of the Mechanical Insulators Labor Management Cooperative Trust [LMCT] and a National Union Insulation Contractors Alliance (NUICA). FMIA will mandate that mechanical insulation will be included as an approved energy and water saving measure to address efficiency needs identified by required evaluations of federal buildings. The federal government is the single largest energy consumer in the United States. Appx 350,000 buildings used more than 344 trillion Btu of energy and 119 billion gallons of water last year. Mechanical insulation will be recognized for lowering operating expenses, reducing energy loss, and decreasing emission. Sounds familiar, our industry has been the loudest voices on trying to get the government to get some type of registration passed for years.

The bill will require that an insulator has to be qualified by completing an apprenticeship registered under the National Apprenticeship Act of 1937. The bill will go to Congress this spring for approval. We will have to wait and see if Congress approves this.

With all the outdoor activities coming up, I found that stretching is important for any fitness routine. I know for a fact that my golf swing now requires a lot of stretching for my back and shoulders. Stretching helps to improve the blood flow and circulation to your muscles and improves your oxygen levels for a better performance. In addition to physical benefits, stretching can reduce stress and improve wellness. Reducing stress is always a great thing.

The Spring MICA meeting is just around the corner, June 19th thru the 21st. If you have not registered, please do. As always, we have great speakers and activities lined up for the meeting. Plus, beautiful mountain views and cool nights for outdoor outings.

Best regards and stay healthy.

Sincerely,  
Doug Barton

### MICA LEADERSHIP:

- **President** Doug Barton, Midwest Insulation Services, Omaha, NE.
- **President-Elect** Lee Stuckenschmidt, Systems Undercover, Eaton, CO.
- **Vice-President** Kevin Rambo, F & H Insulation, Kechi, KS.
- **Associate President** Darrell Peil, Knauf Insulation, Rock Hill, SC.

### MICA BOARD OF DIRECTORS:

- Doug Barton, Midwest Insulation Services, Omaha, NE.
- Lee Stuckenschmidt, Systems Undercover, Eaton, CO.
- Kevin Rambo, F & H Insulation, Inc.
- Matt Hymer, Midwest Materials Co.
- Carl Peterson, Delta Thermal Services
- Jeff Adair, KW Specialty Services
- Ted Nickel, Mavo Sytsems, Inc.
- George Shimada, Gagnon Incorporated
- Matt Lillig, Cornerstone Services Group
- Steve Sack, Sprinkmann Insulation, Inc.
- Darrell Peil, Knauf Insulation

**MIDWEST INSULATION CONTRACTORS ASSOCIATION  
ANNUAL CONVENTION REGISTRATION FORM**  
Cheyenne Mountain Resort – Colorado Springs, CO  
June 18 - 22, 2023

*Please print clearly or Register and Pay Securely Online at [www.micainsulation.org](http://www.micainsulation.org).  
Use a separate form for each registration, and duplicate form as necessary.*

COMPANY NAME \_\_\_\_\_

ATTENDEE NAME \_\_\_\_\_

SPOUSE/GUEST NAME \_\_\_\_\_

CHILDREN NAME(S) if Registered \_\_\_\_\_

BILLING ADDRESS \_\_\_\_\_

CITY \_\_\_\_\_

STATE \_\_\_\_\_

ZIP \_\_\_\_\_

E-MAIL \_\_\_\_\_

OFFICE PHONE \_\_\_\_\_

CELL PHONE \_\_\_\_\_

**First Time Attendee**       Yes       No

**CONFERENCE REGISTRATION:**

	<b>Number</b>	<b>Total</b>
First Attendee from MICA Member Firm - <b>\$825.00</b>	_____	\$ _____
Each additional Attendee from the Same Member Firm - <b>\$800.00</b>	_____	\$ _____
First Couple from MICA Member Firm (Member & Spouse/Guest) - <b>\$1,650.00</b>	_____	\$ _____
Each additional Couple from the Same Member Firm - <b>\$1,600.00</b>	_____	\$ _____
Non-Member Attendees - <b>\$900.00</b> Per Person	_____	\$ _____
Children Under 18 - <b>\$0.00</b> No Charge ( <b>Welcome Reception and Farewell Breakfast Only</b> )	_____	\$ _____

**Member/Spouse Opening Breakfast:**

I/We (will) (will not) attend the Opening Session Breakfast on Tuesday, June 20<sup>th</sup>. The Number Attending is \_\_\_\_\_

**Gala Dinner/Dance:**

I/We (will) (will not) attend the Gala Dinner/Dance on Wednesday Evening, June 21<sup>st</sup>. The Number Attending is \_\_\_\_\_

**Farewell Breakfast/Brunch:**

I/We (will) (will not) attend the Farewell Breakfast on Thursday Morning, June 22<sup>nd</sup>. The Number Attending is \_\_\_\_\_

**ADDITIONAL ACTIVITIES:**

**25th Annual "Mick Van Horn Memorial" Scramble Golf Tournament:**

Golf Tournament Registration - \$180.00	Name: _____	Handicap _____	\$ _____
Golf Club Rental - \$75.00	Please Specify: (Men/Womens Clubs) (Left/Right-Handed) _____		
Golf Tournament Registration - \$180.00	Name: _____	Handicap _____	\$ _____
Golf Club Rental - \$75.00	Please Specify: (Men/Womens Clubs) (Left/Right-Handed) _____		

**Golf Registration Fee includes lunch, 18 holes of golf, shared golf cart, complimentary use of practice and range area, and prizes.** Slacks or Bermuda length shorts, **collared shirt** and non-metal spiked golf or tennis shoes are required. Cut-offs and T-shirts are prohibited anywhere on the premises.

**Tuesday Spouse/Guest Outing: Downtown Colorado Springs Food Tour**

<input type="checkbox"/> \$0.00 Free of Charge (18 or older)	<input type="checkbox"/> \$0.00 Free of Charge (under 18)	Name: _____
<input type="checkbox"/> \$0.00 Free of Charge (18 or older)	<input type="checkbox"/> \$0.00 Free of Charge (under 18)	Name: _____
<input type="checkbox"/> \$0.00 Free of Charge (18 or older)	<input type="checkbox"/> \$0.00 Free of Charge (under 18)	Name: _____
<input type="checkbox"/> \$0.00 Free of Charge (18 or older)	<input type="checkbox"/> \$0.00 Free of Charge (under 18)	Name: _____

**COMPLIMENTRAY CONVENTION SHIRT:**

**Each MICA Member (not including spouses) will receive a complimentary shirt if registration is completed by May 19, 2023.**

No, I do not require a shirt.

Yes, I would like a (Mens/Womens) Polo Sport Shirt in Size (S, M, L, XL, 2XL, 3XL, 4XL) Name: \_\_\_\_\_

Additional shirts, jackets and windshirts can be ordered on the Shirt Order Form separate from this registration form.

**TOTAL PAYMENT DUE:** \$ \_\_\_\_\_

Check to MICA       MasterCard       VISA       American Express       Discover

Name of Cardholder: \_\_\_\_\_ Credit Card Number: \_\_\_\_\_

Exp. Date: \_\_\_\_\_ CSV: \_\_\_\_\_ Billing Zip Code: \_\_\_\_\_

**CANCELLATION POLICY:**

All cancellations must be received in writing. 100% Refund on Cancellations Received Prior to May 19<sup>th</sup>; 75% Refund on Cancellations Received Prior to June 1, 2023; **No Refund on Cancellations Received After June 1, 2023.**

**Please Register Securely Online or return your completed Registration Form with payment by May 19, 2023, to:**

**MICA 7250 Poe Ave. Ste. 410 Dayton, OH 45414**

**E-Mail to [mica@micainsulation.org](mailto:mica@micainsulation.org)**

**Fax to 937-278-0317**

**QUESTIONS: Contact the MICA Office at: 888-294-0084 or [mica@micainsulation.org](mailto:mica@micainsulation.org)**

**MIDWEST INSULATION CONTRACTORS' ASSOCIATION**  
**Schedule of Events**  
**2023 Annual Convention**  
**Cheyenne Mountain Resort - Colorado Springs, CO**

**SUNDAY, JUNE 18, 2023**

- 1:00 p.m. Executive Committee Meeting (Closed)
- 3:00 p.m. Past Presidents' Planning Committee Meeting (Closed)
- 5:30 p.m. Past Presidents' and Board of Directors' Dinner (By Invitation)

**MONDAY, JUNE 19, 2023**

- 9:00 a.m. - 12:00 p.m. Board of Directors Meeting (Closed)
- 12:30 p.m. - 5:00 p.m. **General Registration and MICA Hospitality Room Open**
- 1:00 p.m. - 5:00 p.m. Manual Committee Meeting (Closed)
- 1:00 p.m. - 2:15 p.m. **Promotion & Membership Committee Meeting (Open to All Attendees)**
- 2:30 p.m. - 3:45 p.m. **Young Professionals Committee Meeting**  
(Open to All Attendees under 40 or with less than 5 years' experience in the industry)
- 4:00 p.m. - 5:00 p.m. **First Time Attendee Orientation and Reception**
- 5:00 p.m. - 6:00 p.m. **Associate Sponsored Opening Night Welcome Reception**
- Evening Open **Dinner on Your Own**

**TUESDAY, JUNE 20, 2023**

- 8:00 a.m. - 8:45 a.m. **Member/Spouse Plated Breakfast and Opening Remarks**
- 8:45 a.m. - 10:15 a.m. **Keynote Presentation**  
*with Dave Dravecky*

Dave Dravecky's story is one of finding hope, courage, and perseverance in the midst of dark and overwhelming uncertainty. In 1988, he was at the top of his game and his life. Not only did he have a wonderful family, but he was also at the peak of his career, playing the game of his childhood dreams. His opening day victory over the Dodgers was overshadowed later that fall by the discovery of cancer and the removal of half of the deltoid muscle in his pitching arm. You won't want to miss Dave tell of his life experiences and how he discovered the value and significance of relationships - relationships with co-workers, family members and anyone else on 'his team.'

- 10:30 a.m. - 11:45 a.m. **It Takes More than a Hard Hat to Keep a Head Safe: The Value of Mental Health Awareness in the Construction Industry**  
*with Mandy McIntyre, Level Up Consultants*

When you think about jobsite hazards, physical risks are probably at the top of the list - an unprotected fall, an unmarked restricted zone, etc. But what about the dangers you can't see? Construction workers are statistically at a higher risk for mental health issues

than virtually every other profession and have the highest suicide rates of all industries according to the Centers for Disease Control and Prevention (CDC) and the Substance Abuse and Mental Health Services Administration (SAMHSA). A 2020 study found that 83% of construction workers have experienced a mental health issue.

This session will provide solid solutions and resources on the value of mental health awareness initiatives to provide safer job sites, a more profitable business, and combating the labor shortage by helping to attract, engage and retain your workforce.

10:45 a.m. – 2:30 p.m.

**Downtown Colorado Springs Food Tour - Spouse/Guest Program**

This 3-hour private guided lunch tour will start at the hotel where we will be met by a trained tour leader who will share local history of Colorado Springs on our way downtown to the restaurants. At each of the four stops, guests will be treated to food paired with alcoholic drinks (if over 21) and fun behind-the-scenes information about each location. You won't want to miss this super fun and memorable experience!

12:00 Noon

**Golf Tournament – Shotgun Start at 1:00 p.m.**

The Country Club of Colorado is surrounded by the jagged peaks of the Rocky Mountains. This Pete Dye-designed course was created to challenge golfers of all skill levels.

Afternoon and Evening Open **Dinner on Your Own**

**WEDNESDAY, JUNE 21, 2023**

7:00 a.m. - 8:20 a.m.

**Safety & Environmental Committee Meeting (Open to All Attendees)**

8:30 a.m. – 9:15 a.m.

**Annual Meeting of the Membership and Election of Board of Directors  
Recognition of “Best Practices in Safety” Participants**  
*with Gary Auman, MICA Legal Counsel*

9:15 a.m. – 9:50 a.m.

**“Better Together” with NIA President, Laura Dover of Dover Insulation  
NIA’s Education Center for Mechanical Insulation**  
*with Michele Jones, Executive Vice-President/CEO of NIA.*

10:00 a.m. – 11:00 a.m.

**Manpower Shortages, Recruitment Strategies, and Enticing People to Choose  
Mechanical Insulation as their Career**

*with Tom Fischer, Executive Director North Atlantic States Carpenters Training Fund*

Tom will share the step-by-step process that has taken place during the New England Carpenters Union Apprenticeship and Training Program’s transition from struggling to recruit and retain apprentices to an organization that is now able to choose the best and brightest to fill the future needs of the New England and New York State construction economy. Topics of discussion will include defining company and organizational needs, effective outreach, vetting of candidates, the effectiveness of social media, high school internships, diversity needs, and creating a culture of respect that will attract the next generation of craftspeople. In addition, Tom will share the specific tools that have been used over the past five years as well the data that is used to drive decision making.

11:00 a.m. – 12:00 p.m.

**Open Forum Discussions:**

- ❖ Union Contractors Forum –Ted Nickel, Moderator.
- ❖ Open Shop Contractors Forum – Adam DeGraaf, Moderator.
- ❖ Associate Member Forum – Darrell Peil, Moderator.

Afternoon Open

**Open to Enjoy the Sites of Colorado Springs**

6:30 p.m.- 11:00 p.m.            **Gala Reception, Dinner, and Dance (Casual Dress)**

**THURSDAY, JUNE 22, 2023**

7:30 a.m.                            **Board of Directors Meeting (Closed)**

9:00 a.m. - 10:30 a.m.            **Farewell Breakfast Buffet, Sports Awards, and Prizes**

**NOTE:** This is a tentative schedule of times and events. The final schedule and starting times for some events may vary from this tentative schedule.

**DRESS CODE:** The dress code for the convention is casual for all events including the Tuesday evening dinner. This year, the Tuesday Evening Gala Reception and Dinner is casual dress (Florida Casual Attire Acceptable – No shorts or cut-offs please).





# AEROCEL<sup>®</sup> IS NOW AEROFLEX<sup>®</sup>

The same American-made EPDM closed-cell elastomeric foam insulation that you've come to know and trust.

Aeroflex USA  
232 Industrial Park Road Sweetwater, TN 37874  
866.237.6235  
[www.aeroflexusa.com](http://www.aeroflexusa.com)



## PIC PLASTICS

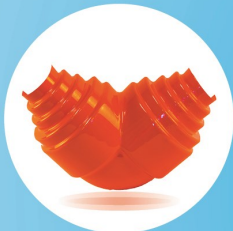

Victaulic Fittings



Long Radius Fittings



Accessories



Short Radius Fittings

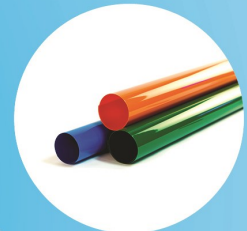

Cut and Curl Jacketing

**1.800.654.0409**

**[pic-plastics.com](http://pic-plastics.com)**

quickest turnaround time | industry-leading customer service | no upcharge for color

The Ultimate

# Protection

## DUCT & PIPE SEALING SYSTEM

FlexClad® is a self-adhering, sheet-type waterproofing membrane that protects critical HVAC duct and piping against the harshest environments. The product is easy to install, conforms to odd shapes, and self-seals around penetrations for complete waterproofing protection. Backed by a 10-year warranty, FlexClad® offers the Ultimate Protection!



Aluminum



White



Almond

**UV Stable, Weather Resistant and Waterproof.**



# FLEX CLAD®

DUCT & PIPE  
WATERPROOFING MEMBRANE

*Exceeds 25/50 Flame/Smoke Rating  
and features a durable  
Cross-Laminated Construction*

**mfm**® BUILDING PRODUCTS CORP.

[www.flexclad.com](http://www.flexclad.com) | 800-882-7663



Watch our video on YouTube for installation instructions.



9th Edition available now!

# NORTH AMERICAN COMMERCIAL & INDUSTRIAL INSULATION STANDARDS

The *North American Commercial & Industrial Insulation Standards* manual is developed by the Midwest Insulation Contractors Association (MICA) to serve as a useful resource for commercial and industrial insulation professionals. Widely accepted as industry standards, the manual is a "must-have" guide for contractors, engineers, architects, and specifiers.

This latest edition includes: updates to existing plates, several new plates, a new flashing section, and updated information for material specifications and standards. The 9th Edition is available both in printed and interactive PDF versions. The digital version includes the manual in a PDF eBook plus the 121 MICA Insulation Plates in an interactive format useful for job submittals. Each version is a one-time cost.

**Choose the PDF e-Book or Printed Edition: \$399  
Get both for \$499**

[micainsulation.org](http://micainsulation.org)  
937-278-0308  
or 888-294-0084  
Fax: 937-278-0317  
[mica@micainsulation.org](mailto:mica@micainsulation.org)

Endorsed by:

**NIA** National Insulation Association

**TIAC**  **ACIT**

Thermal Insulation Association of Canada Association Canadienne de l'Isolation Thermique

## Your Expert Insulation Suppliers



### BAY INSULATION SUPPLY

With unrivaled customer service and industry expertise, a proven track record, competitive pricing, a national footprint, and a wide range of service capabilities, we can provide all the mechanical insulation and HVAC supplies you need.

### SERVICE FROM 29 LOCATIONS

Tempe, AZ  
480-967-1881

Tucson, AZ  
520-777-0303

City of Industry, CA  
626-626-2700

Concord, CA  
925-691-9880

North Highlands, CA  
916-978-9071

San Diego, CA  
858-530-0414

Aurora, CO  
303-371-0505

Iowa City, IA  
319-248-7602

Countryside, IL  
708-352-9663

Indianapolis, IN  
317-782-1144

Lexington, KY  
859-254-0399

Fridley, MN  
763-502-9977

Kansas City, MO  
816-920-5900

St. Louis, MO  
314-776-2002

Las Vegas, NV  
702-891-5333

Cincinnati, OH  
513-563-8200

Cleveland, OH  
216-362-7338

Columbus, OH  
614-345-0804

Portland, OR  
503-248-9662

Fort Worth, TX  
817-617-4383

Garland, TX  
972-278-4900

Houston, TX  
713-675-1811

Round Rock, TX  
512-582-0929

San Antonio, TX  
210-610-9950

Kent, WA  
425-251-6750

Mount Vernon, WA  
360-399-6627

Spokane Valley, WA  
509-893-3411

Green Bay, WI  
920-406-4100

Milwaukee, WI  
414-258-9333

\*Firestop materials available at select locations\*

[www.BayInsulationSupply.com](http://www.BayInsulationSupply.com)

# A Global Leader in Distribution and Specialty Fabrication Products and Services

Pipe, Duct, Tank & Equipment Insulation

HATS® Engineered Head Segments

Pipe Supports, Metal and PVC Jacketing

Fire Protection Products

Absorption Plus® Acoustic Panels and Specialties

Building Envelope Insulation

PG Board TAF™ Parking Garage Insulation

SafeLite® UL Listed Fixture Covers

Refractory Products

Safety Equipment and Tools

Serving Mechanical Insulation, Spray Foam,  
and Metal Building Insulation Markets  
Call (855) 355-5075 for all your insulation needs!

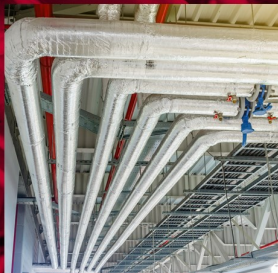

**Specialty Products  
and Insulation**

2101 Rexford Road  
Suite 300E  
Charlotte, NC 28211  
Phone: (855) 355-5075  
www.spi-co.com

Together, we work side by side to create solutions that  
make your projects more efficient, productive, and profitable.

*That's the power of partnership.*

Learn more:



## Total Construction Jumps in March to Three Month High, Bolstered by Nonbuilding Strength

Despite economic woes and bank failures, construction shows strength across Q1

**HAMILTON, NJ — April 20, 2023** — Total construction starts increased 19% in March to a seasonally adjusted annual rate of \$1.09 trillion, according to Dodge Construction Network. During the month, nonresidential starts rose 33%, nonbuilding starts increased 17%, and residential starts moved 5% higher.

In Q1 of 2023, total construction starts were 9% below that of 2022. Year-to-date, residential starts were down 29%, nonresidential and nonbuilding starts grew 6% and 12% respectively. For the 12 months ending March 2023, total construction starts were 11% higher than the 12 months ending March 2022. Nonresidential and nonbuilding starts were 33% and 21% higher, respectively, while residential starts lost 11%.

“Construction starts activity has yet to see the impact of tightening financial conditions in the wake of the failure of Silicon Valley and Signature Banks,” said Richard Branch, chief economist for Dodge Construction Network. “Several large manufacturing projects are breaking ground; pushing nonresidential buildings higher, while a nascent recovery in single family starts has been supporting residential growth. Construction starts began the year with gusto, but that is likely to erode as the year progresses, as seen by the declining trend in the Dodge Momentum Index, which tracks projects entering the earliest stages of planning.”

- **Nonbuilding construction starts** gained 17% in March to a seasonally adjusted annual rate of \$263 billion. Miscellaneous nonbuilding was the only category to post a month-over-month loss. Environmental public works rose 35%, utility/gas plants gained 16%, and highway and bridge starts were up 13%. Year-to-date across Q1, nonbuilding starts gained 12%. Miscellaneous nonbuilding starts were up 43%, environmental public works rose 22%, utility/gas plants moved 8% higher, while highway and bridge starts gained 1%.

For the 12 months ending March 2023, total nonbuilding starts were 21% higher than the 12 months ending March 2022. Utility/gas plant starts rose 32%, and highway bridge starts

increased 16%. Environmental public works and miscellaneous nonbuilding starts were up 20% and 23%, respectively, on a 12-month rolling sum basis.

**The largest nonbuilding projects to break ground in March** were the \$606 million I-35 Capital Express North Lanes in Austin, Texas, the \$445 million Klamath River Renewal Project, in Oregon, which involves the removal of hydroelectric dams, and the \$375 million 360 MW Atrisco Solar Farm in Rio Rancho, New Mexico.

- **Nonresidential building starts** increased 33% in March to a seasonally adjusted annual rate of \$492 billion. Manufacturing starts more than doubled over the month and once again were the driving force behind the gain as three very large projects got underway. Without these projects, total nonresidential starts would have only gained 3%. Commercial starts rose 28%, with retail as the only category to fall, while institutional starts improved 11% due to numerous healthcare projects getting underway. On a year-to-date basis through three months, total nonresidential starts were 6% higher than the first three months of 2022. Institutional starts gained 21%, manufacturing starts were 1% higher, while commercial starts were down 5%.

For the 12 months ending March 2023, total nonresidential building starts were 33% higher than the 12 months ending March 2022. Manufacturing starts were 122% higher, institutional starts improved 22%, and commercial starts gained 18%.

**The largest nonresidential building projects to break ground in March** were the \$5.5 billion Hyundai EV plant in Ellabell, Georgia, the \$3.0 Panasonic Energy North America Battery Manufacturing Plant, and the \$780 million third phase of the BASF MDI chemical plant in Geismar, LA.

- **Residential building starts** increased 5% in March to a seasonally adjusted annual rate of \$335 billion. Single family starts rose 4%, and multifamily starts increased 8%. On a year-to-date basis through three months, total residential starts were down 29%; single family starts were 37% lower, while multifamily starts were down 12%.

For the 12 months ending in March 2023, residential starts were 11% lower than the 12 months ending in March 2022. Single family starts were 23% lower, while multifamily starts were up 16% on a rolling 12-month basis.

(continued to page 15)

# COST EFFECTIVE REPRESENTATION

*for Your Business*

- OSHA
- Workers' Comp Defense
- Labor & Employment Law
- Construction Law



Gary W. Auman

**Auman  
Mahan + Furry**  
ATTORNEYS

[www.amfdayton.com](http://www.amfdayton.com) • (937) 223-6003

## SAVE THE DATE

MICA 66th Annual Convention —  
June 18-22, 2023,  
Cheyenne Mountain Resort, Colorado Springs, CO.  
**ROOM BLOCK CUT-OFF DATE:** Friday, May 19, 2023

MICA Fall 2023 Annual Fall Business Meeting —  
November 7-9, 2023,  
Omaha Marriott Downtown at the Capitol District, NE  
**ROOM BLOCK CUT-OFF DATE:** Friday, October 6, 2023

2024 MICA Winter Board & Committee Meetings  
January 25-27, 2024  
Scottsdale Plaza Resort  
**ROOM BLOCK CUT-OFF DATE:** December 26, 2023

MICA 67th Annual Convention —  
June 2024,  
In Region; Sites Under Consideration.

MICA 68th Annual Convention —  
June 16-19, 2025,  
Hyatt Regency Coconut Point Resort, Bonita Springs, FL.

## MICA MEMBER ADDRESS/INFO. UPDATES

Be sure to inform the MICA office of any changes or corrections to your listing for either the MICA Directory, e-mail correspondence or mailing address. **Even if you update your company listing on the MICA website, please inform the MICA office of the changes.** We try to be as current as possible with your help.

  
**NDT Seals, Inc.**

Zac Sebren  
Director

PO Box 52878 Houston, TX 77052-2878 USA  
tel 713.222.7584 cell 281.995.7916 fax 713.222.9404  
zac@ndtseals.com

Manufacturer of NDT Inspection Plugs and NDT Inspection Point Labels



  
NDTSeals.com

ISO 9001:2015 Certified Quality Management System

FAST . ACCURATE . EASY-TO-LEARN

 **FastWRAP**<sup>TM</sup>

ESTIMATING SOFTWARE  
for Mechanical Insulation



from the maker of FastPIPE and FasDUCT

 **FastEST**, Inc.  
ESTIMATING SOFTWARE

1.800.828.7108 | [fastest-inc.com/mica](http://fastest-inc.com/mica)

The largest multifamily structures to break ground in March were a \$400 million mixed-use in Jamaica, New York, the \$225 million Chestnut Commons Affordable Housing project in Cypress Hills, New York, and the \$268 million Knox mixed-use development in Dallas, Texas.

Regionally, total construction starts in March rose in all five regions.

**March 2023 CONSTRUCTION STARTS**

**MONTHLY CONSTRUCTION STARTS**

(Millions of Dollars, Seasonally Adjusted Annual Rate)

	Mar 2023	Feb 2023	% Change
Nonresidential Building	\$492,423	\$369,178	33
Residential Building	335,006	318,491	5
Nonbuilding Construction	262,875	225,012	17
<b>Total Construction</b>	<b>\$1,090,304</b>	<b>\$912,681</b>	<b>19</b>

**YEAR-TO-DATE CONSTRUCTION STARTS**

Unadjusted Totals, in Millions of Dollars

	3 Mos. 2023	3 Mos. 2022	% Change
Nonresidential Building	\$91,172	\$85,999	6
Residential Building	78,313	110,363	-29
Nonbuilding Construction	55,400	49,546	12
<b>Total Construction</b>	<b>\$224,885</b>	<b>\$245,908</b>	<b>-9</b>

Source: Dodge Construction Network

**THE DODGE INDEX**

(2000=100, Seasonally Adjusted)

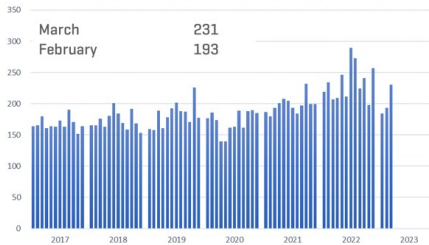

**About Dodge Construction Network**

Dodge Construction Network leverages an unmatched offering of data, analytics, and industry-spanning relationships to generate the most powerful source of information, knowledge, insights, and connections in the commercial construction industry.

The company powers four longstanding and trusted industry solutions—Dodge Data & Analytics, The Blue Book Network, Sweets, and IMS—to connect the dots across the entire commercial construction ecosystem. Together, these solutions provide clear and actionable opportunities for both small teams and enterprise firms. Purpose-built to streamline the complicated, Dodge Construction Network ensures that construction professionals have the information they need to build successful businesses and thriving communities. With over a century of industry experience, Dodge Construction Network is the catalyst for modern commercial construction. To learn more, visit [construction.com](http://construction.com)



**SSL II® WITH ASJ MAX FIBERGLAS™ PIPE INSULATION**



Contact Your Midwest Regional Sales Team:

**Tom McGettigan**  
 MN, WI, Eastern IA, IL, IN, and Western KY • 317-790-9265  
 Tom.McGettigan@owenscorning.com

**Jacob Aelker**  
 MT, ND, SD, NE, Western IA, KS, and MO • 419-906-0062  
 Jacob.Aelker@owenscorning.com

**Gavin Forehand**  
 WY, CO, ID, UT, WA, OR, NV, and AK • 419-906-0062  
 Gavin.Forehand@owenscorning.com



Learn more at [www.owenscorning.com/mechanical](http://www.owenscorning.com/mechanical)

THE PINK PANTHER® & © 1964–2022 MGM. The color PINK is a registered trademark of Owens Corning. © 2022 Owens Corning. All Rights Reserved.



**allied insulation supply**

Primary Insulation Distributor

- |                     |                            |                                    |
|---------------------|----------------------------|------------------------------------|
| <b>Accessories</b>  | <b>Facings</b>             | <b>Metal Fittings &amp; Jacket</b> |
| Adhesives & Mastics | Fiberglass Batt & Board    | Mineral Wool Batt & Board          |
| Calcium Silicate    | Fiberglass Pipe Insulation | Pipe & Tank                        |
| Custom Fabrication  | Fire Stop Materials        | Polystyrene Board                  |
| Duct Wrap/Board     | ISO Board                  | PVC Fittings & Jacket              |
| EIFS                | Metal Building Insulation  | Sealants                           |

**800-242-9970**

**milwaukee • davenport • omaha • wausau**

*"If it's insulation we stock it!"*  
[www.alliedinsulation.com](http://www.alliedinsulation.com)

**FOLLOW OUR SOCIALS!**



@MidwestInsulationContractorsAssociation



**100% RIGHT**  
IF IT DOESN'T FIT RIGHT,  
IT'S NOT FIT TIGHT.



- ✓ Piping System Covers: Valve, Flange, Strainer, Pump, Flow Meter, Manway
- ✓ Exhaust System Covers
- ✓ Turbine Insulation Covers

- ✓ Freeze Protection (Covers with Heating Elements)
- ✓ Equipment (Heat Exchangers, Fuel heaters, Reactors)
- ✓ Process Control / Heat Retention



Fit Tight Covers unique fabrication process is based on 25 years of testing and development, resulting in the best designed insulation covers utilizing the best materials.

**FitTightCovers.com**  
**812-492-3370**



# Serving the Midwest with Commercial & Industrial Insulation Since 1986

**4-STATE  
SUPPLY**

## Commercial & Industrial Insulation

4-State Supply has earned the reputation as the distributor of choice for mechanical and architectural insulation, green insulation products, and fire stopping and safety materials. We value our clients - offering responsive service, in-depth product knowledge and fast, reliable delivery. Let our team support your team. Service available from three locations.

**Lenexa, KS**

913-894-9484

14305 W 105th St.  
Lenexa, KS 66215

**Omaha, NE**

402-359-1095

6101 N. 16th St.  
Omaha, NE 68110

**Wichita, KS**

316-337-5293

3833 N Bridgeport Circle  
Wichita, KS 67219



Visit our website at [www.4statesupply.com](http://www.4statesupply.com)  
For more information, contact us at [info@4statesupply.com](mailto:info@4statesupply.com)



Since 1983, Cook Brothers Insulation has set the standard in custom fabricating rigid insulation in shapes and sizes for all kinds of pipes, fittings, valves, vessels and specialty heads. Our dedication to top quality products, customer service, fast lead times, and competitive pricing have earned our reputation as the best in the industry.

Call or email us today for all of your insulation needs.

**STYROFOAM™**  
**TRYMER®**  
**FOAMGLAS®**  
**PHENOLIC**

**Email: [sales@cookbro.com](mailto:sales@cookbro.com)**  
**Toll Free: 800-624-3043**  
**Fax: 816-842-4031**  
**[www.cookbro.com](http://www.cookbro.com)**

***We carry all  
the accessories  
you need to get  
the job done.***



# TANI DIVISION

## Removable/Reusable Insulation Blankets

- Custom Fit and Fabricated
- Ideal for Turbines, Vessels, Pumps, Valves, Exhausts, Instruments, Expansion Joints, etc.
- Provide Personnel Protection
- 1 Year Payback with Energy Savings
- Welding Cloth & Industrial Fabrics Available
- Over 40 years of Fabricating Experience

Contact Us Today!

320-845-4733 | [www.tanidivision.com](http://www.tanidivision.com)





## Thank you for **43 years of partnership.**

Since 1980, Proto Corporation has been working hard to earn the trust of our customers, manufacture the highest quality products and deliver the industry's best service. Thank you for your continued support.

(800) 875-7768 | [ProtoCorporation.com](https://www.ProtoCorporation.com)



# Brauer Supply Co.

**HEATING, COOLING, INSULATION, FASTENERS, AND AIR FILTRATION  
WHOLESALE AND DISTRIBUTORS  
ESTABLISHED 1881**

Visit our Web Site at [www.brauersupply.com](http://www.brauersupply.com)

**CORPORATE HEADQUARTERS**

1218 South Vandeventer Ave.  
St. Louis, MO 63110  
Phone: (314) 534-7150  
Toll-Free: (800) 392-8776  
Fax: (314) 534-1816

**Insulation Headquarters**

1218 South Vandeventer Ave.  
St. Louis, MO 63110  
Phone: (314) 534-7150  
Toll-Free: (800) 392-8776  
Fax: (314) 534-6867

3320 Brown Station Road  
Columbia, MO 65202  
(573) 442-1171  
(800) 322-3120  
Fax: (573) 875-0730

1788 US 61 S.  
Festus, MO 63028  
(636) 931-8600  
(877) 931-8600  
Fax: (636) 931-8601

2652 So. Old Orchard Rd.  
Jackson, MO 63755  
(573) 243-4877  
(800) 367-4889  
Fax: (573) 243-9484

1802 Katherine Street  
Joplin, MO 64801  
(417) 624-9600  
(866) 845-0733  
Fax: (417) 624-9602

74 S. James St  
Kansas City, KS 66118  
(913) 281-3100  
(877) 589-6838  
Fax: (913) 281-3103

1231 Tom Ginnever Ave.  
O'Fallon, MO 63366  
(636) 978-6700  
(800) 284-8838  
Fax: (636) 978-6720

491 Davis Blvd  
Sikeston, MO 63801  
(573) 481-0600  
(866) 919-0700  
Fax: (573) 481-0612

1475 Taylor Avenue  
Springfield, IL 62703  
(217) 544-0265  
(888) 544-0265  
Fax: (217) 544-0715

3105-A East Elm  
Springfield, MO 65802  
(417) 862-7117  
(866) 284-4032  
Fax: (417) 862-7997

105 Service Street  
Swansea, IL 62226  
(618) 233-1733  
(877) 534-7150  
Fax: (618) 233-4426

498 Dubois Valley Dr.  
Union, MO 63084  
(636) 583-8855  
(800) 585-8856  
Fax: (636) 583-8266

[www.RPRHouston.com](http://www.RPRHouston.com)



*Metal Jacketing Specialists*

**RPR Products, Inc.**



**INSUL-MATE® Products**

- Roll Jacketing & Sheeting
- 2-Piece aluminum & T316 Stainless Steel Pressed Elbows
- Strapping, Seals, Springs and Screws
- 4 Inch Box Rib Sheets
- Insul-Box® Aluminum Siding
- 7.2" Rib Siding

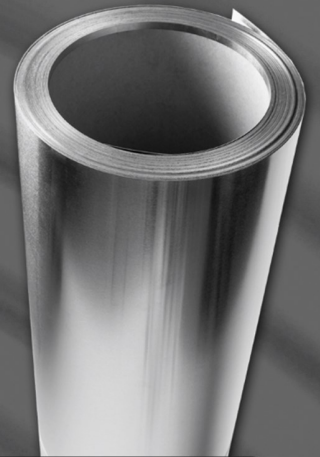

**ACOUSTI-MATE®**

- Acoustical Jacketing
- Aluminum and Stainless Steel Perforated Rolls and Sheeting



407 DELZ | HOUSTON TEXAS 77018 | 713.697.7003 | 800.231.0149



# FyreWrap® Elite 1.5

Duct Insulation



## FyreWrap® Has You Covered!

Best in class product, systems and support for grease duct enclosure.

- ✔ Easy to install, saves labor
- ✔ No bulky overlaps, saves space and material
- ✔ Listed systems assures code compliance
- ✔ Engineering Judgments provided quickly
- ✔ Certified online installation training
- ✔ HVAC Duct, Plenum and Dryer Exhaust systems also available
- ✔ Made in the USA

Cross section of applied insulation



Alkegen Fire Protection Contacts:

**Application Engineering:**  
716-768-6298

**National Sales Manager:**  
Alan Shepherd: 919-695-5002

**Area Manager:**  
Tim Walter: 281-203-7553

**ALKEGEN**  
alkegen.com

# TRYMER® PIR

Guiding You Through LNG Systems

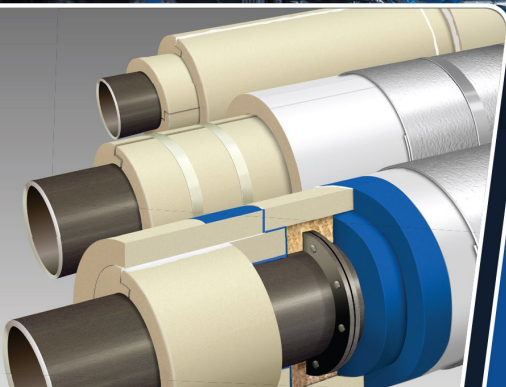

TRYMER® PIR, is a closed-cell, high-performance insulation with a broad temperature range, giving you the perfect insulation solution for not only heated applications but also cryogenic applications, like those found in LNG plants.

- *Economical*
- *Easy to fabricate & install*
- *Superior thermal performance*
- *Available in a variety of densities and thicknesses*
- **NEW!** *LNG systems guide now available*

**JM** **Johns Manville**  
A Berkshire Hathaway Company

Download the  
**LNG Systems Guide**





# MACARTHUR Co.

Building Materials • Employee Owned



## FIBERGLASS INSULATION

- Pipe insulation
- Duct wrap
- Fiberglass board
- PVC Jacketing
- PVC Fittings
- Pipe & Tank wrap

## INSULATION ACCESSORIES

- Elastomeric pipe insulation
- Pre-cut metal jacketing --Metal fittings (LR, SR & Victualic)
- PVC, FSK, FOIL & ASJ Tapes
- Rubber sheet & roll goods
- Banding & Fasteners



## ABOUT US

MacArthur Co. is an employee-owned company and has been a partner for contractors in the mechanical insulation & HVAC market since 1913. We put our customers first and consistently strive to provide the highest level of customer service possible.

## OTHER MARKETS SERVED

- Fiberglass duct liner
- HVAC connection systems (Ductmate & DuroDyne)
- Duct gasketing & sealants
- Commercial Roofing
- Wall Systems and cladding
- Elastomeric duct liner
- Residential Roofing





**US Department of Labor announces launch of 'Beat the Heat' contest**

*OSHA seeking new tools to increase awareness of heat hazards at work*

WASHINGTON – Do you have an idea for helping workers stay safe in the heat? The U.S. Department of Labor's Occupational Safety and Health Administration today announced the launch of a nationwide competition for stakeholders in all industries to share their best tools and other resources for informing workers about the dangers of heat exposure in indoor and outdoor workplaces.

OSHA's "Beat the Heat" contest seeks to educate workers and employers about workplace heat hazards, raise industry and general public awareness of the dangers excessive heat presents to workers, and motivate employers and workers to act to prevent heat illness.

Open to stakeholders in all industries, the competition will be judged by a panel of subject matter experts in OSHA and other federal agencies. The panel will choose winners based on the following factors:

- Innovation
- Creativity
- Strength of message
- Best non-English language entry
- Indoor heat emphasis
- Young Worker emphasis

**All submissions must be received by June 9, 2023.**

Visit the [OSHA Beat the Heat contest webpage](#) for contest rules and submission instructions. Send questions about participation to [heatcampaign@dol.gov](mailto:heatcampaign@dol.gov).

Winning submissions will be displayed on OSHA's website and featured in the agency's QuickTakes and The Heat Source newsletters. Winners will also receive a letter of appreciation from Assistant Secretary for Occupational Safety and Health Doug Parker, a Beat the Heat Challenge Coin and a congratulatory certificate.



Office: 903.464.0556 - Toll Free: 888.464.0556 - Fax: 903.464.0558  
 2407 Texoma Drive - P.O. Box 543 - Denison, TX 75020

**PTF**  
 Insulation Fabricators  
**INSULATION FABRICATORS**  
*The Right Fit Every Time!*

**QUALITY AND EXCELLENCE  
 ANY PIPING CONFIGURATION**

"THERE IS A PTF SOLUTION  
 FOR EVERY CONCEIVABLE  
 INSULATION TASK."  
*Obed Mendoza*

**Fabricated Pipe**  
 Extruded Polystyrene  
 Foamglas®  
 Isocyanurate  
 Phenolic

**Insulation Supplies**  
 Fittings  
 Metal Jacket  
 PVC Jacketing  
 Rubber & fiberglass

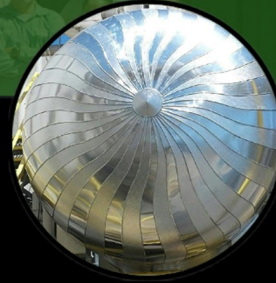

Visit  
 PTFfabricators.com  
 for

Products  
 Samples  
 Customer Login  
 Company Info  
 Contact Us

**PTF**  
 Insulation Fabricators  
**INSULATION FABRICATORS**  
 Quality Fabricated Industrial & Commercial Insulation Products  
*The Right Fit Every Time!*



2407 Texoma Drive  
 Denison, Texas 75020

**Obed  
 Mendoza**

Office: 903.464.0556  
 Toll Free: 888.464.0556  
 Fax: 903.464.0558

AccountsManager@ptffabricators.com

www.PTFfabricators.com

**PTF**  
 Insulation Fabricators  
**INSULATION FABRICATORS**  
 Quality Fabricated Industrial & Commercial Insulation Products  
*The Right Fit Every Time!*

	Trymer 2000	Styrofoam	Fiberglass	Mineral Wool	Foamglas®
K-factor Btu·in/hr·ft²·°F 180 days 75 °F mean	0.19	0.25	0.23	0.25 (@ 100 °F)	0.29
R-value, 1 inch hr·ft²·°F/Btu 180 days 75 °F mean	5.3	4.0	4.3	4.2	3.5

www.PTFfabricators.com

An Energy Conservation Fabricator

**IPS**

**INSPECTION PLUG STRATEGIES, LLC**



**Sealing CUI test sites  
 couldn't be easier!**

Products Manufactured  
 by Inspection Plug Strategies LLC



- ✓ Designed for use with aerogel blanket applications
- ✓ Also fits traditional thicker insulations
- ✓ Self-sealing attachment with smooth & corrugated jacketing
- ✓ Installs without screws but accommodates them if needed



System II



System V



TMLX



TML



UTL 2



UTL 3



UTL 4



UTL 5



2437 Bay Area Blvd. #147 | Houston, TX 77058  
 281-480-4406 | 1-800-914-4406 | mcb@inspectionplugstrategies.com

IPSPugs.com





# polyguard

## Providing Moisture Control Solutions for over 60 Years

Long known for its weatherproof cladding and vapor barriers, Polyguard now offers superior insulation systems (including protection from CUI) targeting below ambient and chilled water applications and a complete line of pipe supports and tools from Buckaroos.



### Alumaguard

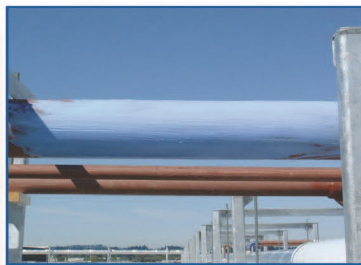

### RG-2400



### Styrofoam XPS

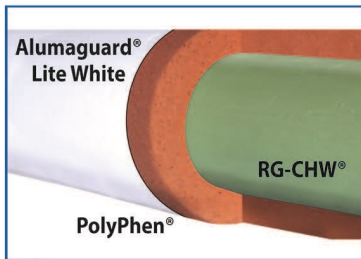

### PolyPhen



### Insulrap/ZeroPerm



### Pipe Supports

- Weatherproof Jacketing • CUI protection
- Vapor Barriers • Insulation • Pipe Supports

The DOW logo is a registered trademark and STYROFOAM is a trademark of The Dow Chemical Company ("Dow") or an affiliated company of Dow



## polyguard

214-515-5000

[www.polyguard.com/mechanical](http://www.polyguard.com/mechanical)



## BUCKAROOS

Innovation based. Employee owned. Expect more.  
A Polyguard Company

800-969-3113

[www.buckaroos.com](http://www.buckaroos.com)

Buckaroos is now a Polyguard Company

# SURESHOT

**Hand-Held Technology times "TWO"**

**2x Tough \* 2x Fast \* 2x Portable**



SureShotII changes your concept of pin welding...times TWO. Be it Cupheads, Weld Pins, or even Weld Studs -- SureShotII can deliver. With updated Hybrid Technology and Dual Operating Power, SureShotII uses the best of all worlds to provide Capacitor Discharge fastener welding second to none. In the lightweight and rugged packaging you've come to expect from SureShot (weighing in at 18 lbs.) this Welder has the power to weld virtually any Stud fastener known to the CD application market: with only 110volt (or 220volt incoming power). User-friendly, the system offers multi-level safety and operational designs to get the job done quickly, safely and reliably --- truly delivering the power of "II".

Width: 13.7" (347mm)

**Your  
SINGLE SOURCE  
Insulation Fastening  
StudWelding  
Specialists**

1-800-852-8352 • 450 Richard Street • Miamisburg, Ohio 45342 • [midwestfasteners.com](http://midwestfasteners.com)



## Extol Fabricated Metal Covers

### SETTING THE STANDARD THROUGH CUSTOMIZATION

When it comes to engineering a quality product, one size does not fit all. Extol Fabricated Metal Covers are designed based on information that is unique to your application. They are fabricated to your specification.

### BROAD RANGE OF SIZES AND SHAPES

Extol Fabricated Metal Covers are fabricated in a broad range of shapes that includes but is not limited to the following: End Caps, Reducers, Flange Covers, 90's, 45's, Tees, Tank Heads and Valve Covers. A variety of alloys, thicknesses and finishes are available to match your application.



## CONNECT WITH REGIONAL VETERANS' EMPLOYMENT COORDINATORS

Are you an employer interested in hiring transitioning service members, veterans and/or military spouses? The DOL Veterans' Employment and Training Service (DOL VETS) has Regional Veterans' Employment Coordinators who can help connect you with federal, state and local resources to facilitate veterans' employment. DOL VETS also has an [Employer Guide to Hiring Veterans](#) that includes information on veteran demographics, resources for employers, and recommendations on how to attract, train and retain veterans. Reach out to DOL VETS today to see how they can help you connect veterans to your Registered Apprenticeship programs. [CONNECT NOW](#)



### SHAPING THE INDUSTRIAL INSULATION MARKET FOR OVER 35 YEARS

208 Republic Street, Norwalk, OH 44857  
ExtolOhio.com • info@extolohio.com  
800-486-9865 • 419-668-2072 • Fax: 419-663-1992



SAFETYJACS®

WHAT IF YOU COULD PROVIDE BETTER

## SAFETY & PRODUCTIVITY?

- INCREASE YOUR PRODUCTIVITY
- REDUCE SAFETY RISKS
- PROTECT YOUR ASSETS
- PROTECT YOUR HANDS
- OPTIMIZE YOUR WORKFORCE

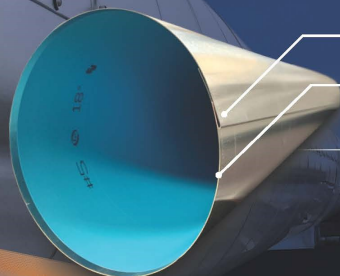

1/2" SAFETY HEM

FACTORY DEBURRED EDGES

SafetyJacs® has become the standard in cut & roll jacketing, that are **safer, quicker** and **easier** to install.

**Safer. Smarter. Faster.**

To learn more about our products visit [IDEALPRODUCTS.CA](http://IDEALPRODUCTS.CA)



MIDWEST INSULATION CONTRACTORS ASSOCIATION  
7250 POE AVENUE, SUITE 410  
DAYTON, OHIO 45414  
(888) 294-0084  
e-mail: mica@micainsulation.org  
www.micainsulation.org



# THE PREFERRED CHOICE FOR CONTRACTORS

Your trusted resource for high-performance commercial and industrial insulation projects. Let us handle your insulation needs!

## Committed to Service and Excellence

[www.owenscorning.com/insulation](http://www.owenscorning.com/insulation)  
[www.foamglas.com](http://www.foamglas.com)

## For more information, contact the expert!

Rob English  
314-503-0001  
[Rob.English@owenscorning.com](mailto:Rob.English@owenscorning.com)

©2023 Owens Corning. All Rights Reserved.

